

LED Outdoor Luminaires Ceiling Mount - Vapor Tight 120-277 VAC / 60Hz

Model #: VTL243500LAJD2
VTL476000LAJD2

Safety Precautions

- Read all safety precautions and installation instructions carefully before installing or servicing this fixture. Failure to comply with these instructions could result in potentially fatal electric shock and/or property damage.
- It is recommended that a qualified electrician perform all wiring. This fixture must be wired in accordance with all national and local electrical codes.
- Do not handle any energized fixture or attempt to energize any fixture with wet hands or while standing on a wet or damp surface or in water.
- This fixture is designed for use in a 120-277VAC, 60Hz fused circuit. This fixture is compatible with 0-10V dimming circuit.
- To reduce the risk of electrical shock, and to assure proper operation, this fixture must be adequately grounded. To accomplish proper grounding, there must be a separate ground wire (green) contact between this fixture and the ground connection of your main power supply panel.
- This fixture is intended to be used for general outdoor lighting in dry, damp or wet locations. For wet locations, fixture must be mounted at least 48 inches above ground level.
- Disclaimer

Changes or modifications not expressly approved by the party responsible for compliance could void the user's authority to operate the equipment. NOTE: This equipment has been tested and found to comply with the limits for a Class B digital device, pursuant to Part 15 of the FCC Rules and Canadian ICES-005 (B) / NMB-005 (B). These limits are designed to provide reasonable protection against harmful interference in a residential installation. This equipment generates, uses and can radiate radio frequency energy and, if not installed and used in accordance with the instructions, may cause harmful interference to radio communications. However, there is no guarantee that interference will not occur in a particular installation. If this equipment does cause harmful interference to radio or television reception, which can be determined by turning the equipment off and on, the user is encouraged to try to correct the interference by one or more of the following measures:

- Reorient or relocate the receiver antenna.
- Increase the separation between the equipment and receiver.
- Connect the equipment into an outlet on a circuit different from that to which the receiver is connected.
- Consult with the dealer or an experienced radio/TV technician for help.

Any modifications to this fixture may void the warranty and interfere with the safe operation of the luminaire.

Operation is subject to the following two conditions: (1) this device may not cause interference, and (2) this device must accept any interference, including interference that may cause undesired operation of the device.

Assembly Instructions

Step 1 – Preparing for installation

- Disconnect electrical power** at fuse or circuit breaker box before installing or servicing any part of this fixture.
- Carefully remove the LED fixture from the carton.
- Release the diffuser (2) from the fixture (1) by unlatching all mechanical latches. Diffuser is tethered to the latch on both ends.
- Release LED plate assembly (6) from clip brackets. LED plate is tethered to housing (1).
- Identify location of mounting brackets on fixture relative to power source. Holes are supplied for power connection at end or through the top. Fitting is supplied for cord connection. If top is used for connection, remove knockout and install plastic cap (6) onto the front end for water tight seal.
- A set of replacement plastic latches are provided if factory installed metal latches (8) are not desirable. Pull on the latch to unsnap it from the groove. To install snap new latch by aligning pin onto the receiving groove in reverse order of removal.

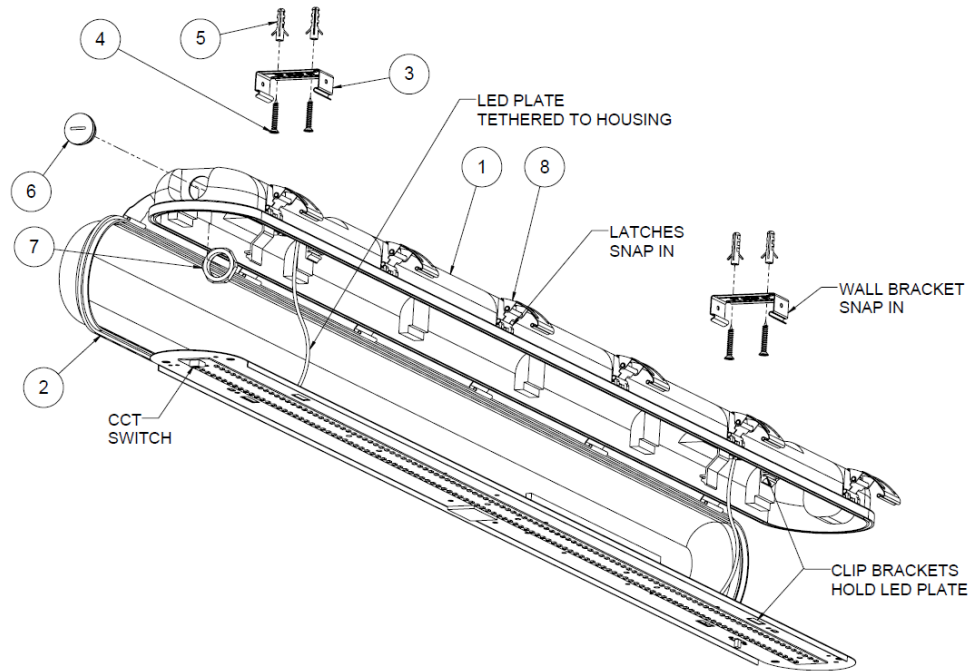

Step 2 – Mounting fixture

- Select location for mounting the fixture. Two brackets (3) are supplied with drywall anchors & screws (4) & (5). Follow drilling dimension for brackets spacing for 48" or 24" fixture.
- To locate, hold fixture assembly up to ceiling with power supply hole located over entryway for power supply wires. Mark the locations of the mounting holes for brackets (3) on the ceiling.
- Take the fixture down and punch a small hole into the ceiling at each location using a nail or awl to see if there is a wood joist. Attach to surface using fasteners and sealing washers (not provided) appropriate to ceiling materials.
- If there is a joist, use a suitable wood screw (4) to mount the fixture housing. Where there is no joist to screw into, use drywall anchors (4) & (5) or toggle bolts (not provided) of suitable length to mount housing securely to the ceiling.
- Mount the fixture with appropriate fasteners while passing the supply wires into the opening of the housing.

Wiring – All wiring must take place inside junction box (not included)

Caution: Make sure power is off at fuse or circuit breaker box. Check power wires for damage or scrapes. Use wire suitable for at least 90°C (194°F). **Note:** Most dwellings built before 1985 have supply wire rated to 60C. Consult a qualified electrician ensure correct branch circuit conductor before installing.

Step 3 – Wiring fixture

- Make all wire connections to appropriate wire. Secure with wire nut and power connectors (supplied).
- Strip off 1/2" insulation to expose bare wires on supply power source black (L) and white (N).
- Connect the green wire from the fixture to the supply power source ground wire.
- For none dimming fixture.** Connect the black wire from the fixture to the black (L) wire from supply power source. Connect the white wire from the fixture to the white (N) wire from supply power source. Pink and purple wires are not to be used and must be individually capped to prevent shorting.
- For (0-10V) dimming fixture.** Connect the pink wire from the fixture to the dimmer source gray wire. Connect the purple wire from the fixture to the dimmer source purple wire. Connect the white wire from the fixture to the neutral (N) wire from dimming source per dimmer wiring instructions. Connect the black wire from the fixture to the control line (L) wire from dimmer supply power source per dimmer wiring instructions.

LED Outdoor Luminaires Ceiling Mount - Vapor Tight 120-277 VAC / 60Hz

Model #: VTL243500LAJD2
VTL476000LAJD2

- F. Do not mix wires. Pull on each wire lead to make sure connections are secure. Make certain no bare wires are exposed outside of wire connectors.
- G. Re-install LED plate to the clip brackets in the housing (1).

Step 4 – Color changing temperature adjustment, CCT (if desired)

- A. Adjust CCT switch according to the desired color temperature as shown below. Note: Fixture is preset to 3000K from factory.

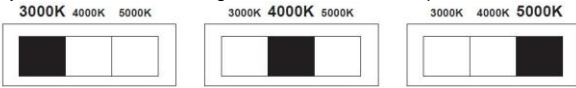

Step 5 – Diffuser installation

- A. Install diffuser (2) onto housing by securing latches, rotating/alternating around edge of housing and capturing diffuser with rounded lip. Snap latches closed. Twelve latches for 48" and six for 24" version.

Step 6 – Restore power at fuse or circuit breaker box

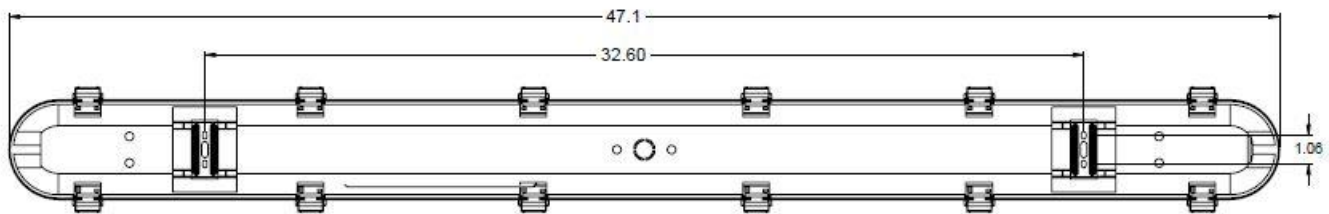

48" MODEL

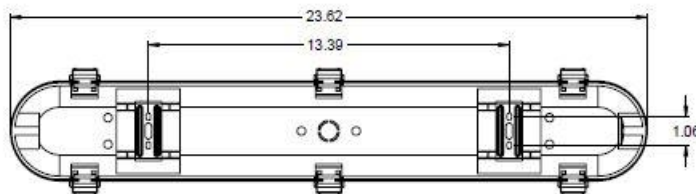

24" MODEL

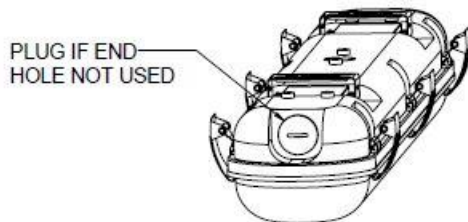

24" MODEL W/CAP

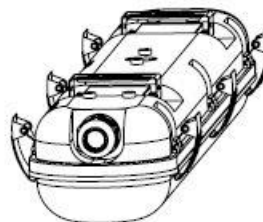

24" MODEL W/CORD CONNECTION

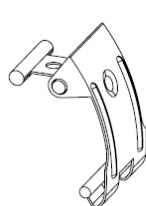

PLASTIC LATCH

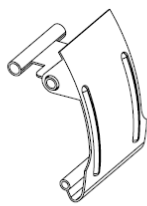

METAL LATCH

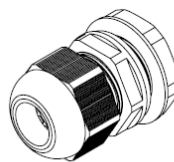

WEATHERTIGHT SEAL CORD CONNECTION



PLASTIC CAP

Limited Factory Warranty

AFX warrants this fixture is free from defects in materials and workmanship when installed and used under normal operating conditions for a period of 5 years from date of purchase. This warranty covers all component parts and extends only to replacement of defective fixture or components; it does not cover failure due to improper installation, misuse, mishandling or damage incurred in transit.