

INSTALLATION INSTRUCTIONS

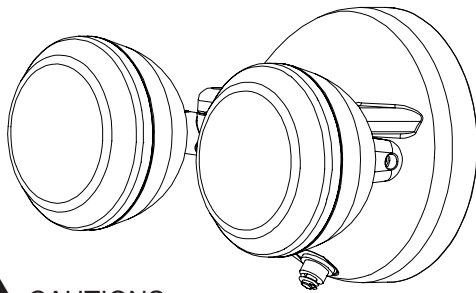

CAUTIONS

THIS PRODUCT MUST BE INSTALLED IN ACCORDANCE WITH THE APPLICABLE INSTALLATION CODE BY A PERSON FAMILIAR WITH THE CONSTRUCTION AND OPERATION OF THE PRODUCT AND THE HAZARDS INVOLVED; CE PRODUIT DOIT ÊTRE INSTALLÉ SELON LE CODE D'INSTALLATION PERTINENT, PAR UNE PERSONNE QUI CONNAÎT BIEN LE PRODUIT ET SON FONCTIONNEMENT AINSI QUE LES RISQUES INHÉRENTS.

CONSULT A QUALIFIED ELECTRICIAN TO ENSURE CORRECT BRANCH CIRCUIT CONDUCTOR BEFORE INSTALLING.
 "CONSULTER UN ÉLECTRICIEN QUALIFIÉ POUR VOUS ASSURER QUE LES CONDUCTEURS DE LA DÉRIVATION SONT ADÉQUATS".

1. Please read and understand this entire manual before attempting to assemble, install, or operate this light fixture.
2. This fixture is designed for use in a 120VAC / 60Hz fused circuit. This fixture is not compatible with dimming circuit.
3. Some codes require installation by a qualified electrician.
4. This light fixture must be properly grounded.
5. Make sure connections are secure using included Wago connector, crimp-on lugs or other UL approved connecting devices.
6. Before installation or servicing, turn the power OFF at the circuit breaker or fuse. Place tape over the circuit breaker switch and verify power is OFF at the light fixture.
7. This fixture is intended to be used for general outdoor lighting in dry, damp, or wet locations. For wet locations, fixture must be mounted at least 48 inches above ground level.
8. MIN 90 °C SUPPLY CONDUCTORS;
 "LES FILS D'ALIMENTATION 90°C MIN" .

**SAVE THESE INSTRUCTIONS
 FOR FUTURE REFERENCE**

MOUNTING

1. Remove the mounting plate (D) from the back of the fixture by loosening the set screw (C) using the Allen wrench (DD). (fig.1)

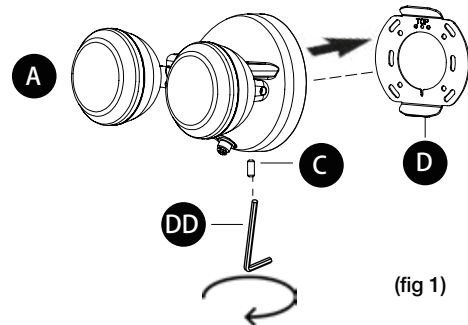

2. Route the junction box wires through the large center hole in the mounting plate (D).
3. Align the holes on the mounting plate (D) with the holes on your junction box. Use two #8 screws (AA) to secure it. Please make sure the "TOP" is upwards. (fig.2)

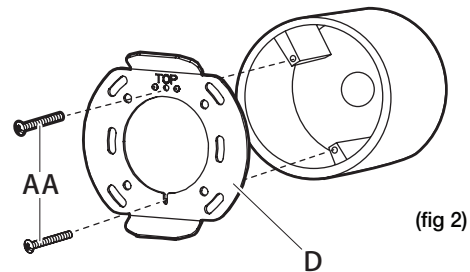

4. Place the small sphere head of the hanger wire (E) between the back of the small groove located on the bottom of the center hole of the mounting plate (D).
5. Ensure the photocell (B) is facing downwards when the light fixture (A) is installed. (fig.3)

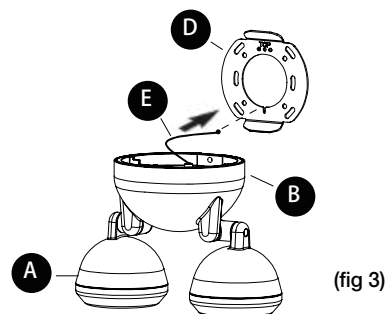

- Complete the electrical connections per the Fixture Wiring section.
- CCT switch is located behind the fixture (fig. 4). Adjust the switch to desired color temperature of 3000K, 4000K, or 5000K. Note: Fixture is preset to 3000K from factory.

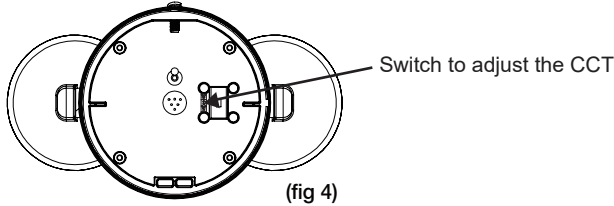

- Once wiring connections are done, place the light fixture (A) onto the mounting plate (D). Verify the fixture is flush with the mounting surface.
- Tighten the set screw (C) on bottom of the fixture (A) to secure it.(fig.5)

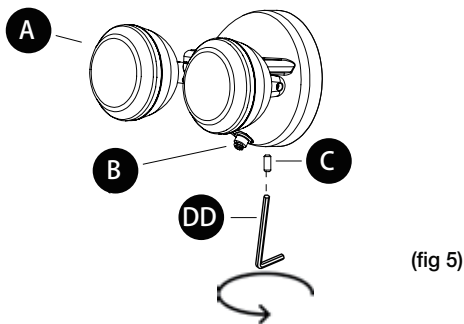

- Apply a small bead of silicone (not included) per manufacturer's instruction around the perimeter of the fixture (A) where it contacts with the surface of the wall or ceiling.
- Restore power at the fuse or circuit breaker box.

- To enable dusk-to-dawn operation, remove the black cap cover installed on the fixture, and replace it with a clear cap cover included in the hardware kits. Note: Ensure the photocell is unobstructed.
- Ensure the switch powering the outlet connected to the light fixture is turned to the ON position and leave it ON at all times to enable dusk -to-dawn functionality to operate automatically.

OPTION2: SWITCH CONTROLLED

- To enable switch activated operation leave the black cap cover on the photocell

CARE AND CLEANING

- Shut off the main power supply before cleaning the fixture. To prolong the original appearance, clean the light fixture with clear water and a soft, damp cloth only.
- Do not use abrasive cleaners or cleaners that contain alcohol. Do not apply paints, solvents, or any other chemicals on this light fixture. They could cause a premature deterioration of the finish and may void the warranty. Do not spray the light fixture with a hose or power washer

FCC NOTE

This equipment has been tested and found to comply with the limits for a Class B digital device, pursuant to Part 15 of the FCC Rules. These limits are designed to provide reasonable protection against harmful interference in a residential installation. This equipment generates, uses and can radiate radio frequency energy and, if not installed and used in accordance with the instructions, may cause harmful interference to radio communications. However, there is no guarantee that interference will not occur in a particular installation. If this equipment does cause harmful interference to radio or television reception, which can be determined by turning the equipment OFF and ON, the user is encouraged to try to correct the interference by one or more of the following measures:

- Reorient or relocate the receiving antenna.
- Increase the separation between the equipment and receiver.
- Connect the equipment into an outlet on a circuit different from that to which the receiver is connected.
- Consult the dealer or an experienced radio/TV technician for help..

This device complies with part 15 of the FCC Rules. Operation is subject to the following two conditions: (1)This device may not cause harmful interference, and (2) this device must accept any interference received. Including interference that may cause undesired operation. The users manual or instruction manual for an intentional or unintentional radiator shall caution the user that changes or modifications not expressly approved by the party responsible for compliance could void the user's authority to operate the equipment.

WIRING

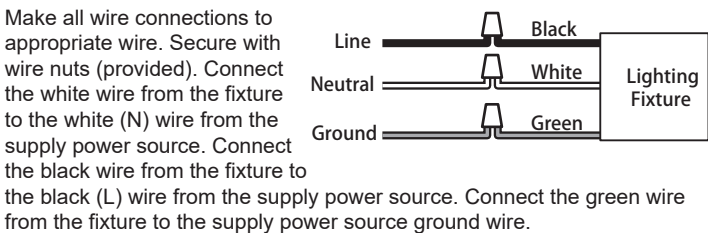

OPERATION

SELECTING DUSK-TO-DAWN OR SWITCH-ACTIVATED CONTROL
OPTION1: DUSK-TO-DAWN OPERATION

Limited Factory Warranty

AFX Inc. hereby warranty that this fixture is free from defects in materials and workmanship when installed and used under normal operating conditions for a period of 5 years from date of shipment from factory. This warranty covers all component parts and extends only to replacement of defective fixture or components; it does not cover failure due to improper installation, misuse, mishandling or damage incurred in transit.